

# Ura

ref. **UR03**

Floor lamp

39,4in

61,4in



20,5in

## Ura Collection



UR01



UR03



UR104



UR204



UR304



UR04-3

## MATERIAL FINISHES

### LAMPSHADE

Painted stainless steel

One color to choose



### CANOPY AND CABLE

Stainless steel

Black cable

Dimmable

## LIGHT SOURCE

### 120V - 60Hz

 E26 Med. - Max. 3x100 W

 E26 Med. - Max. 3x42 W

 E26LED - Max. 3x13 W

upon request:

 GU24 - Max. 3x23 W

## OTHER TECHNICAL DATA

### PACKAGING

43,3x18,5x23,6in

25,8lb

### ELECTRICAL FEATURES



### CERTIFICATIONS



## Ura

ref. **UR03**

Suitable for indoor use, at 77°F

Apta para uso interior a temperatura ambiente de 77°F

Box contains | Contenido de la caja:

**A** - Lampshade | Tulipa [1]

**B** - Top ring | Aro superior [1]

**C** - Patas | Metal legs [3]

**D** - Llave | Key tool [1]

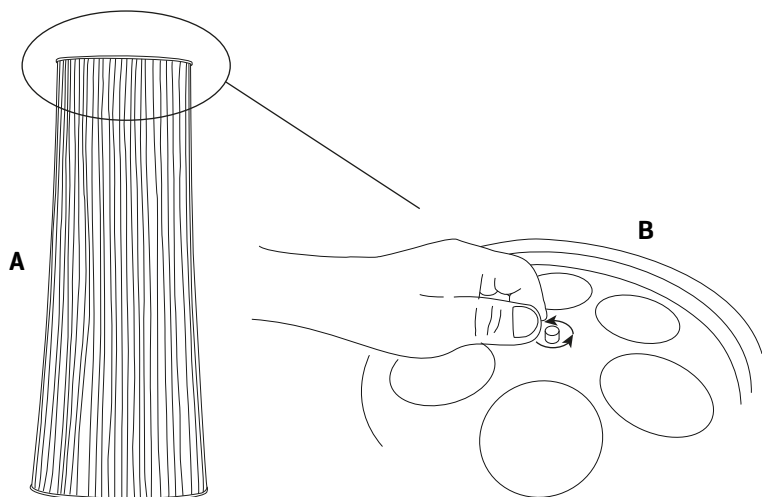

**1**

Place the lampshade as shown in the picture on the left and unscrew the cap at the top that joins the ring bezel.

Coloque la tulipa como se ve en la imagen de la izquierda y en la parte superior desenrosque el tapón que une el aro embellecedor.

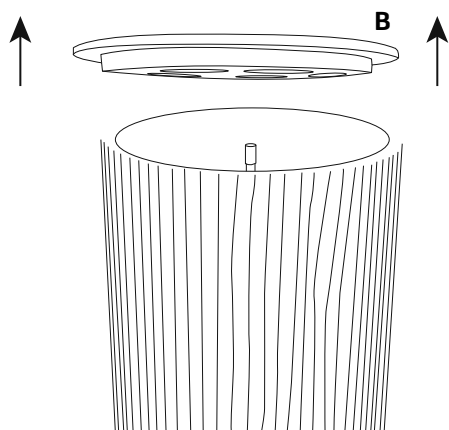

**2**

Carefully remove the ring bezel to access the interior of the luminaire.

Quite el aro embellecedor con cuidado para acceder al interior de la luminaria.

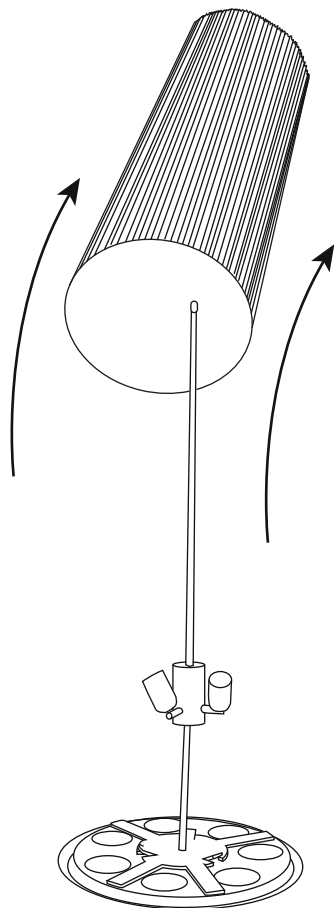

### 3

Take out carefully the lampshade moving it along itself and without bumping over other components

In this way we have discovered the base on which to place the legs and the desired illumination.

**ATTENTION!** This step is complicated, pay attention to the drawings.

Extraer la tulipa al completo desplazándola a lo largo del si misma y teniendo cuidado de no tropezar con otros componentes,

De esta manera tenemos al descubierto la base sobre la que se deben colocar las patas y la iluminación deseada.

**ATENCIÓN!** Este paso es complejo, preste atención a los dibujos.

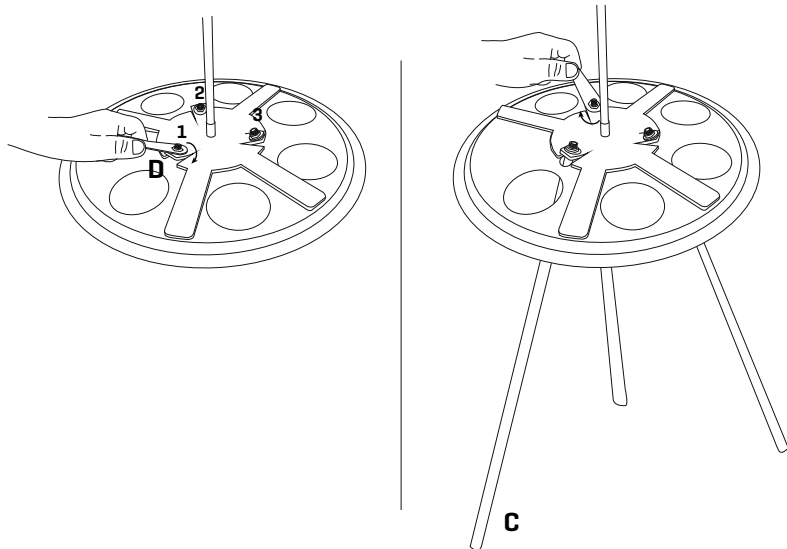

### 4

Across the metal legs under the bottom ring and screwing them into the areas marked with numbers 1-2-3. Tighten the nuts with the tool.

Repeat the steps in reverse order to reassemble the luminaire.

Pase los patas de metal por debajo del aro inferior y enroscándolas en las zonas señaladas con los números 1-2-3. Apriete las tuercas con la herramienta enviada.

Repita los pasos en orden inverso para volver a montar la luminaria.