

IMAGEN



DESCRIPCIÓN

Lámparas de suspensión, pared, sobremesas, plafón y pies de salón con pantalla de roble erosionado en laca decorada en gris o gris oscuro. Todas las pantallas llevan su difusor de poliéster opal. Las partes metálicas pueden ser decoradas en bronce oscuro o latón.

ESPECIFICACIONES GENERALES

Montaje	Techo
Ambiente	Interior
IP	20

MATERIALES

Pantalla	Madera
Base	Metal
Difusor	Acrílico

ACABADOS

Madera	Roble Natural, Roble Oscuro
Metal	Bronce, Latón, Cuero
Acrílico	Satinice

COTAS GENERALES

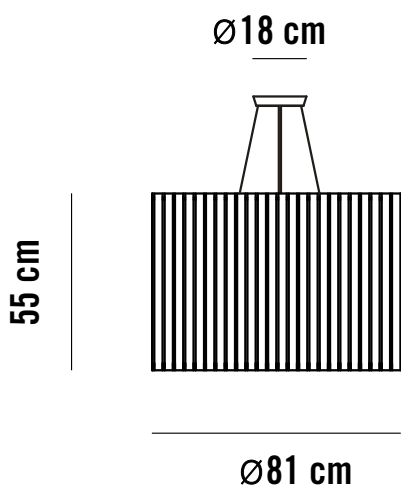

CARACTERÍSTICAS ELÉCTRICAS

Clase de aislamiento	Clase I
Tipo fuente de luz	LED
Tipo LED	E27
Potencia total	3 x 12 W
Temperatura de color	2700K
Voltaje AC	220-240v
Frecuencia	50-60Hz
Regulación (<i>Sujeto a bombilla* regulable</i>)	TRIAC (<i>corde de fase</i>) DALI bajo pedido

* Bombilla no incluida



ACABADOS



DIMENSIONES Y EMBALAJE

Cuerpo	Ø81x55cm
Longitud del cable	200cm
Peso neto	6,9kg
Medidas bulto	90x90x66
Volumen bulto	0,5346m³
Peso bulto	15kg

MANTENIMIENTO

Limpiar con un paño suave. No utilizar productos amoniacales, disolventes o abrasivos.

IMAGE



DESCRIPTION

Pendant, wall, table, ceiling and floor family lamps. Shade made of oak, lacquered and decorated in gray or dark gray. All shades with their opal diffuser made of polyester. The metal parts can be decorated in brass or dark bronze.

GENERAL SPECIFICATIONS

Installation	Ceiling
Ambient	Indoor
IP	20

MATERIALS

Shade	Wood
Body	Metal
Diffuser	Acrylic

FINISHES

Oak	Natural, Dark
Metal	Bronze, Brass, Antique Brass
Acrylic	Satinice

GENERAL DIMENSIONS

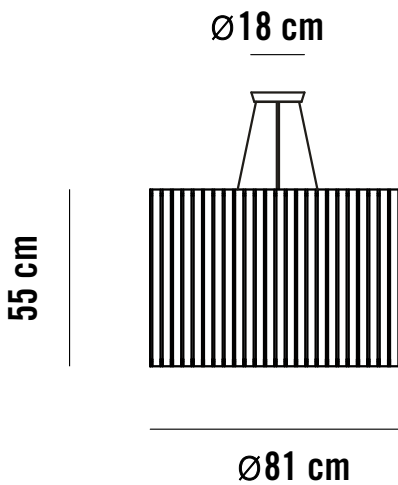

ELECTRICAL CHARACTERISTICS

Safety class	Class I
Light source	LED
LED type	E27
Rated input wattage	3 x 12 W
Colour Temperature	2700K
AC Voltage	220-240v
Frequency	50-60Hz
Dimmer <i>(Subject to dimmable light bulb*)</i>	TRIAC <i>(phase cut)</i> DALI on request

* Light bulb not included



FINISHES

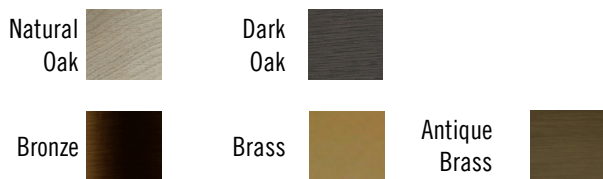

DIMENSIONS AND PACKAGING

Body	Ø81x55cm
Cable length	200cm
Net weight	6.9kg
Box dimension	90x90x66
Box volume	0.5346m³
Total weight	15kg

MAINTENANCE

Clean with a smooth cloth. Do not use ammonia, solvents or abrasive cleaning products.

IMAGEN



DESCRIPCIÓN

Lámparas de suspensión, pared, sobremesas, plafón y pies de salón con pantalla de roble erosionado en laca decorada en gris o gris oscuro. Todas las pantallas llevan su difusor de poliéster opal. Las partes metálicas pueden ser decoradas en bronce oscuro o latón.

ESPECIFICACIONES GENERALES

Montaje	Techo
Ambiente	Interior
IP	20

MATERIALES

Pantalla	Madera
Base	Metal
Difusor	Acrílico

ACABADOS

Madera	Roble Natural, Roble Oscuro
Metal	Bronce, Latón, Cuero
Acrílico	Satinice

COTAS GENERALES

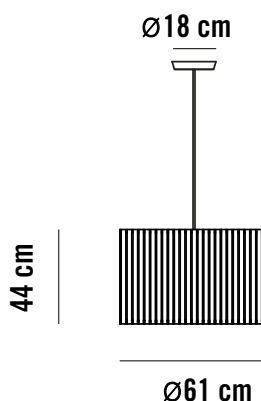

CARACTERÍSTICAS ELÉCTRICAS

Clase de aislamiento	Clase I
Tipo fuente de luz	LED
Tipo LED	E27
Potencia total	1 x 12 W
Temperatura de color	2700K
Voltaje AC	220-240v
Frecuencia	50-60Hz
Regulación (<i>Sujeto a bombilla* regulable</i>)	TRIAC (<i>corde de fase</i>) DALI bajo pedido

* Bombilla no incluida



ACABADOS



DIMENSIONES Y EMBALAJE

Cuerpo	Ø61x44cm
Longitud del cable	200cm
Peso neto	6,40kg
Medidas bulto	70x70x60
Volumen bulto	0,294m³
Peso bulto	10kg

MANTENIMIENTO

Limpiar con un paño suave. No utilizar productos amoniacales, disolventes o abrasivos.

IMAGE



DESCRIPTION

Pendant, wall, table, ceiling and floor family lamps. Shade made of oak, lacquered and decorated in gray or dark gray. All shades with their opal diffuser made of polyester. The metal parts can be decorated in brass or dark bronze.

GENERAL SPECIFICATIONS

Installation Ceiling
 Ambient Indoor
 IP 20

MATERIALS

Shade Wood
 Body Metal
 Diffuser Acrylic

FINISHES

Oak Natural, Dark
 Metal Bronze, Brass, Antique Brass
 Acrylic Satinice

GENERAL DIMENSIONS

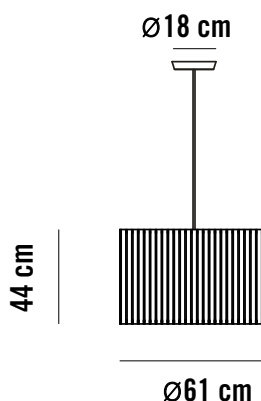

ELECTRICAL CHARACTERISTICS

Safety class Class I
 Light source LED
 LED type E27
 Rated input wattage 1 x 12 W
 Colour Temperature 2700K
 AC Voltage 220-240v
 Frequency 50-60Hz
 Dimmer (Subject to dimmable light bulb*) TRIAC (phase cut)
 DALI on request

* Light bulb not included



FINISHES

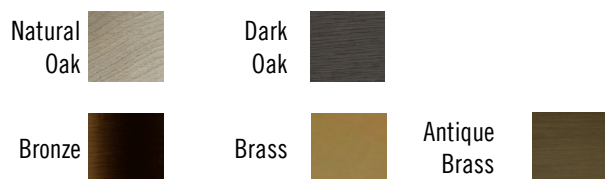

DIMENSIONS AND PACKAGING

Body Ø61x44cm
 Cable length 200cm
 Net weight 6.40kg
 Box dimension 70x70x60
 Box volume 0.294m³
 Total weight 10kg

MAINTENANCE

Clean with a smooth cloth. Do not use ammonia, solvents or abrasive cleaning products.

IMAGEN



* La imagen corresponde al modelo 6021

DESCRIPCIÓN

Lámparas de suspensión, pared, sobremesas, plafón y pies de salón con pantalla de roble erosionado en laca decorada en gris o gris oscuro. Todas las pantallas llevan su difusor de poliéster opal. Las partes metálicas pueden ser decoradas en bronce oscuro o latón.

ESPECIFICACIONES GENERALES

Montaje	Techo
Ambiente	Interior
IP	20

MATERIALES

Pantalla	Madera
Base	Metal
Difusor	Acrílico

ACABADOS

Madera	Roble Natural, Roble Oscuro
Metal	Bronce, Latón, Cuero
Acrílico	Satinice

COTAS GENERALES

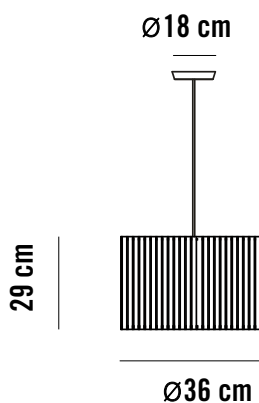

CARACTERÍSTICAS ELÉCTRICAS

Clase de aislamiento	Clase I
Tipo fuente de luz	LED
Tipo LED	E27
Potencia total	1 x 7 W
Temperatura de color	2700K
Voltaje AC	220-240v
Frecuencia	50-60Hz
Regulación (Sujeto a bombilla* regulable)	TRIAC (corte de fase) DALI bajo pedido

* Bombilla no incluida



ACABADOS



DIMENSIONES Y EMBALAJE

Cuerpo	Ø36x29cm
Longitud del cable	200cm
Peso neto	2.20kg
Medidas bulto	40x40x40
Volumen bulto	0.064m³
Peso bulto	4.5kg

MANTENIMIENTO

Limpiar con un paño suave. No utilizar productos amoniacales, disolventes o abrasivos.

IMAGE



* Image not representative of the actual model (REF. 6021)

DESCRIPTION

Pendant, wall, table, ceiling and floor family lamps. Shade made of oak, lacquered and decorated in gray or dark gray. All shades with their opal diffuser made of polyester. The metal parts can be decorated in brass or dark bronze.

GENERAL SPECIFICATIONS

Installation Ceiling
 Ambient Indoor
 IP 20

MATERIALS

Shade Wood
 Body Metal
 Diffuser Acrylic

FINISHES

Oak Natural, Dark
 Metal Bronze, Brass, Antique Brass
 Acrylic Satinice

GENERAL DIMENSIONS

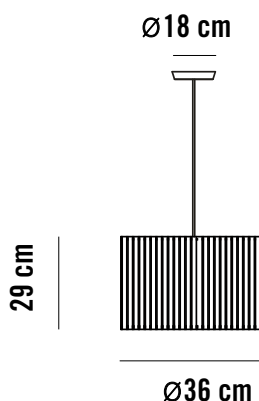

ELECTRICAL CHARACTERISTICS

Safety class Class I
 Light source LED
 LED type E27
 Rated input wattage 1 x 7 W
 Colour Temperature 2700K
 AC Voltage 220-240v
 Frequency 50-60Hz
 Dimmer (Subject to dimmable light bulb*) TRIAC (phase cut)
 DALI on request

* Light bulb not included



FINISHES

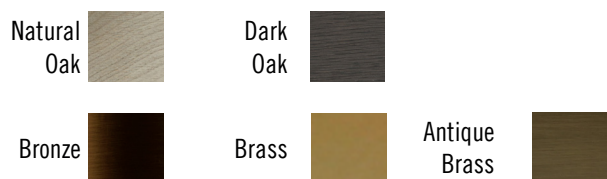

DIMENSIONS AND PACKAGING

Body Ø36x29cm
 Cable length 200cm
 Net weight 2.20kg
 Box dimension 40x40x40
 Box volume 0.064m³
 Total weight 4.5kg

MAINTENANCE

Clean with a smooth cloth. Do not use ammonia, solvents or abrasive cleaning products.

IMAGEN



* La imagen corresponde al modelo 6021

DESCRIPCIÓN

Lámparas de suspensión, pared, sobremesas, plafón y pies de salón con pantalla de roble erosionado en laca decorada en gris o gris oscuro. Todas las pantallas llevan su difusor de poliéster opal. Las partes metálicas pueden ser decoradas en bronce oscuro o latón.

ESPECIFICACIONES GENERALES

Montaje	Techo
Ambiente	Interior
IP	20

MATERIALES

Pantalla	Madera
Base	Metal
Difusor	Acrílico

ACABADOS

Madera	Roble Natural, Roble Oscuro
Metal	Bronce, Latón, Cuero
Acrílico	Satinice

COTAS GENERALES

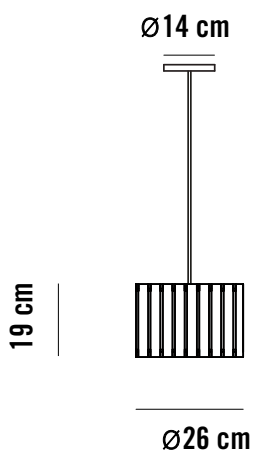

CARACTERÍSTICAS ELÉCTRICAS

Clase de aislamiento	Clase I
Tipo fuente de luz	LED
Tipo LED	E27
Potencia total	1 x 4 W
Temperatura de color	2700K
Voltaje AC	220-240v
Frecuencia	50-60Hz
Regulación (Sujeto a bombilla* regulable)	TRIAC (corte de fase) DALI bajo pedido

* Bombilla no incluida



ACABADOS



DIMENSIONES Y EMBALAJE

Cuerpo	Ø26x19cm
Longitud del cable	200cm
Peso neto	1,05kg
Medidas bulto	30x30x30
Volumen bulto	0,027m³
Peso bulto	2,1kg

MANTENIMIENTO

Limpiar con un paño suave. No utilizar productos amoniacales, disolventes o abrasivos.

IMAGE



* Image not representative of the actual model (REF. 6021)

DESCRIPTION

Pendant, wall, table, ceiling and floor family lamps. Shade made of oak, lacquered and decorated in gray or dark gray. All shades with their opal diffuser made of polyester. The metal parts can be decorated in brass or dark bronze.

GENERAL SPECIFICATIONS

Installation Ceiling
 Ambient Indoor
 IP 20

MATERIALS

Shade Wood
 Body Metal
 Diffuser Acrylic

FINISHES

Oak Natural, Dark
 Metal Bronze, Brass, Antique Brass
 Acrylic Satinice

GENERAL DIMENSIONS

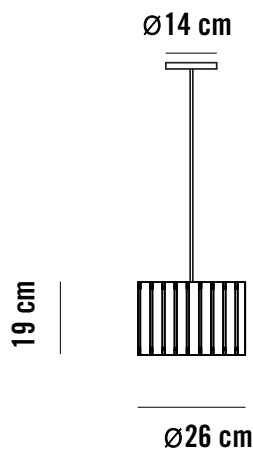

ELECTRICAL CHARACTERISTICS

Safety class Class I
 Light source LED
 LED type E27
 Rated input wattage 1 x 4 W
 Colour Temperature 2700K
 AC Voltage 220-240v
 Frequency 50-60Hz
 Dimmer (Subject to dimmable light bulb*) TRIAC (phase cut)
 DALI on request

* Light bulb not included



FINISHES

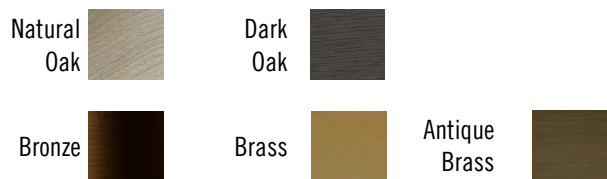

DIMENSIONS AND PACKAGING

Body Ø26x19cm
 Cable length 200cm
 Net weight 1.05kg
 Box dimension 30x30x30
 Box volume 0.027m³
 Total weight 2.1kg

MAINTENANCE

Clean with a smooth cloth. Do not use ammonia, solvents or abrasive cleaning products.

IMAGEN



DESCRIPCIÓN

Lámparas de suspensión, pared, sobremesas, plafón y pies de salón con pantalla de roble erosionado en laca decorada en gris o gris oscuro. Todas las pantallas llevan su difusor de poliéster opal. Las partes metálicas pueden ser decoradas en bronce oscuro o latón.

ESPECIFICACIONES GENERALES

Montaje	Techo
Ambiente	Interior
IP	20

MATERIALES

Pantalla	Madera
Base	Metal
Difusor	Acrílico

ACABADOS

Madera	Roble Natural, Roble Oscuro
Metal	Bronce, Latón, Cuero
Acrílico	Satinice

COTAS GENERALES

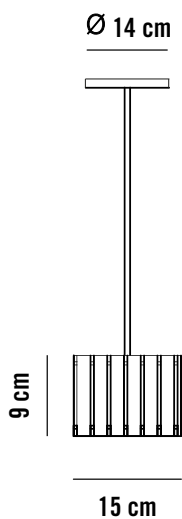

CARACTERÍSTICAS ELÉCTRICAS

Clase de aislamiento	Clase I
Tipo fuente de luz	LED
Tipo LED	G9
Potencia total	1 x 3 W
Temperatura de color	2700K
Voltaje AC	220-240v
Frecuencia	50-60Hz
Regulación (<i>Sujeto a bombilla* regulable</i>)	TRIAC (<i>corde de fase</i>) DALI bajo pedido

* Bombilla no incluida



ACABADOS



DIMENSIONES Y EMBALAJE

Cuerpo	Ø14x9cm
Longitud del cable	200cm
Peso neto	0.7kg
Medidas bulto	20x20x30
Volumen bulto	0.012m³
Peso bulto	1.3kg

MANTENIMIENTO

Limpiar con un paño suave. No utilizar productos amoniacales, disolventes o abrasivos.

IMAGE



DESCRIPTION

Pendant, wall, table, ceiling and floor family lamps. Shade made of oak, lacquered and decorated in gray or dark gray. All shades with their opal diffuser made of polyester. The metal parts can be decorated in brass or dark bronze.

GENERAL SPECIFICATIONS

Installation	Ceiling
Ambient	Indoor
IP	20

MATERIALS

Shade	Wood
Body	Metal
Diffuser	Acrylic

FINISHES

Oak	Natural, Dark
Metal	Bronze, Brass, Antique Brass
Acrylic	Satinice

GENERAL DIMENSIONS

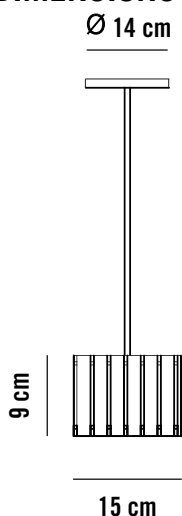

ELECTRICAL CHARACTERISTICS

Safety class	Class I
Light source	LED
LED type	G9
Rated input wattage	1 x 3 W
Colour Temperature	2700K
AC Voltage	220-240v
Frequency	50-60Hz
Dimmer <i>(Subject to dimmable light bulb*)</i>	TRIAC <i>(phase cut)</i> DALI on request

* Light bulb not included



FINISHES

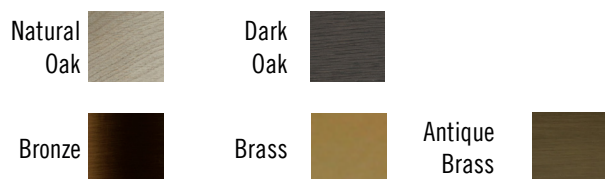

DIMENSIONS AND PACKAGING

Body	Ø14x9cm
Cable length	200cm
Net weight	0.7kg
Box dimension	20x20x30
Box volume	0.012m³
Total weight	1.3kg

MAINTENANCE

Clean with a smooth cloth. Do not use ammonia, solvents or abrasive cleaning products.

IMAGEN



DESCRIPCIÓN

Lámparas de suspensión, pared, sobremesas, plafón y pies de salón con pantalla de roble erosionado en laca decorada en gris o gris oscuro. Todas las pantallas llevan su difusor de poliéster opal. Las partes metálicas pueden ser decoradas en bronce oscuro o latón.

ESPECIFICACIONES GENERALES

Montaje	Suelo
Ambiente	Interior
IP	20

MATERIALES

Pantalla	Madera
Base	Metal
Difusor	Acrílico

ACABADOS

Madera	Roble Natural, Roble Oscuro
Metal	Bronce, Latón, Cuero
Acrílico	Satinice

COTAS GENERALES

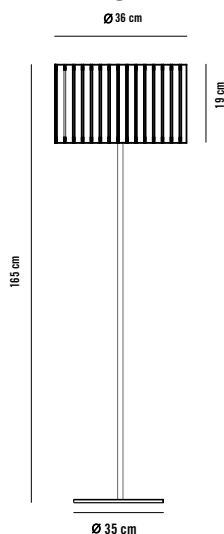

CARACTERÍSTICAS ELÉCTRICAS

Clase de aislamiento	Clase I
Tipo fuente de luz	LED
Tipo LED	E27
Potencia total	1 x 7 W
Temperatura de color	2700K
Voltaje AC	220-240v
Frecuencia	50-60Hz
Regulación (<i>Sujeto a bombilla* regulable</i>)	TRIAC (<i>corde de fase</i>) DALI bajo pedido

* Bombilla no incluida



ACABADOS



DIMENSIONES Y EMBALAJE

Cuerpo	Ø36x165cm
Longitud del cable	170cm
Peso neto	5kg
Medida bulto 1	40x40x40
Medida bulto 2	40x40x25
Medida bulto 3	20x20x170
Volumen bulto 1	0,064m ³
Volumen bulto 2	0,04m ³
Volumen bulto 3	0,068m ³
Peso total bultos	10,9kg

MANTENIMIENTO

Limpiar con un paño suave. No utilizar productos amoniacales, disolventes o abrasivos.

IMAGE



DESCRIPTION

Pendant, wall, table, ceiling and floor family lamps. Shade made of oak, lacquered and decorated in gray or dark gray. All shades with their opal diffuser made of polyester. The metal parts can be decorated in brass or dark bronze.

GENERAL SPECIFICATIONS

Installation Floor
 Ambient Indoor
 IP 20

MATERIALS

Shade Wood
 Body Metal
 Diffuser Acrylic

FINISHES

Oak Natural, Dark
 Metal Bronze, Brass, Antique Brass
 Acrylic Satinice

GENERAL DIMENSIONS

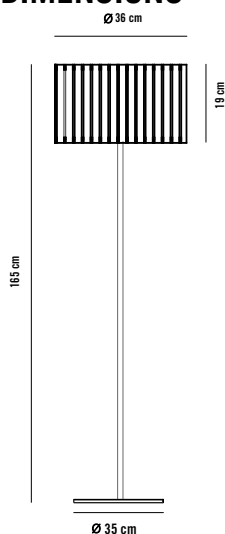

ELECTRICAL CHARACTERISTICS

Safety class Class I
 Light source LED
 LED type E27
 Rated input wattage 1 x 7 W
 Colour Temperature 2700K
 AC Voltage 220-240v
 Frequency 50-60Hz
 Dimmer (Subject to dimmable light bulb*) TRIAC (phase cut)
 DALI on request

* Light bulb not included



FINISHES

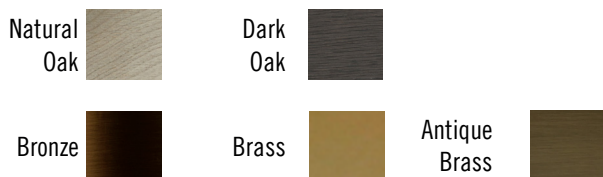

DIMENSIONS AND PACKAGING

Body Ø36x165cm
 Cable length 170cm
 Net weight 5kg
 Box 1 dimension 40x40x40
 Box 2 dimension 40x40x25
 Box 3 dimension 20x20x170
 Box 1 volume 0.064m³
 Box 2 volume 0.04m³
 Box 3 volume 0.068m³
 Total Boxes weight 10.9kg

MAINTENANCE

Clean with a smooth cloth. Do not use ammonia, solvents or abrasive cleaning products.

IMAGEN



* La imagen corresponde al modelo 6023

DESCRIPCIÓN

Lámparas de suspensión, pared, sobremesas, plafón y pies de salón con pantalla de roble erosionado en laca decorada en gris o gris oscuro. Todas las pantallas llevan su difusor de poliéster opal. Las partes metálicas pueden ser decoradas en bronce oscuro o latón.

ESPECIFICACIONES GENERALES

Montaje	Suelo
Ambiente	Interior
IP	20

MATERIALES

Pantalla	Madera
Base	Metal
Difusor	Acrílico

ACABADOS

Madera	Roble Natural, Roble Oscuro
Metal	Bronce, Latón, Cuero
Acrílico	Satinice

COTAS GENERALES

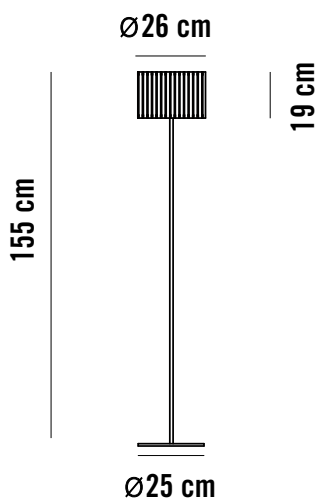

CARACTERÍSTICAS ELÉCTRICAS

Clase de aislamiento	Clase I
Tipo fuente de luz	LED
Tipo LED	E27
Potencia total	1 x 4W
Temperatura de color	2700K
Voltaje AC	220-240v
Frecuencia	50-60Hz
Regulación (Sujeto a bombilla* regulable)	TRIAC (corte de fase) DALI bajo pedido

* Bombilla no incluida



ACABADOS



DIMENSIONES Y EMBALAJE

Cuerpo	Ø26x155cm
Longitud del cable	200cm
Peso neto	3,2kg
Medida bulto 1	20x20x170
Medida bulto 2	30x30x30
Volumen bulto 1	0,064m³
Volumen bulto 2	0,027m³
Peso total bultos	4,5kg

MANTENIMIENTO

Limpiar con un paño suave. No utilizar productos amoniacales, disolventes o abrasivos.

IMAGE



* Image not representative of the actual model (REF. 6023)

DESCRIPTION

Pendant, wall, table, ceiling and floor family lamps. Shade made of oak, lacquered and decorated in gray or dark gray. All shades with their opal diffuser made of polyester. The metal parts can be decorated in brass or dark bronze.

GENERAL SPECIFICATIONS

Installation Floor
 Ambient Indoor
 IP 20

MATERIALS

Shade Wood
 Body Metal
 Diffuser Acrylic

FINISHES

Oak Natural, Dark
 Metal Bronze, Brass, Antique Brass
 Acrylic Satinice

GENERAL DIMENSIONS

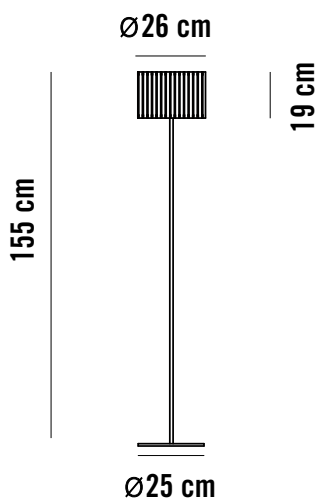

ELECTRICAL CHARACTERISTICS

Safety class Class I
 Light source LED
 LED type E27
 Rated input wattage 1 x 4W
 Colour Temperature 2700K
 AC Voltage 220-240v
 Frequency 50-60Hz
 Dimmer (Subject to dimmable light bulb*) TRIAC (phase cut)
 DALI on request

* Light bulb not included



FINISHES



DIMENSIONS AND PACKAGING

Body Ø26x155cm
 Cable length 200cm
 Net weight 3.2kg
 Box 1 dimension 20x20x170
 Box 2 dimension 30x30x30
 Box 1 volume 0.064m³
 Box 2 volume 0.027m³
 Total Boxes weight 6kg

MAINTENANCE

Clean with a smooth cloth. Do not use ammonia, solvents or abrasive cleaning products.

IMAGEN



* La imagen corresponde al modelo 6023

DESCRIPCIÓN

Lámparas de suspensión, pared, sobremesas, plafón y pies de salón con pantalla de roble erosionado en laca decorada en gris o gris oscuro. Todas las pantallas llevan su difusor de poliéster opal. Las partes metálicas pueden ser decoradas en bronce oscuro o latón.

ESPECIFICACIONES GENERALES

Montaje	Suelo
Ambiente	Interior
IP	20

MATERIALES

Pantalla	Madera
Base	Metal
Difusor	Acrílico

ACABADOS

Madera	Roble Natural, Roble Oscuro
Metal	Bronce, Latón, Cuero
Acrílico	Satinice

COTAS GENERALES

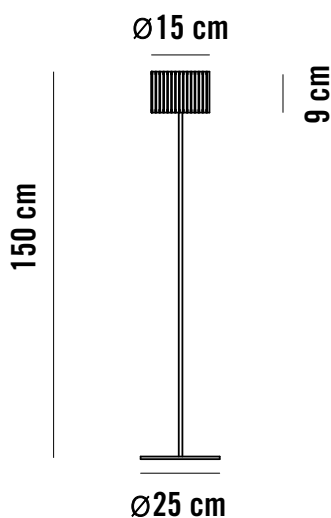

CARACTERÍSTICAS ELÉCTRICAS

Clase de aislamiento	Clase I
Tipo fuente de luz	LED
Tipo LED	G9
Potencia total	1 x 3W
Temperatura de color	2700K
Voltaje AC	220-240v
Frecuencia	50-60Hz
Regulación (Sujeto a bombilla* regulable)	TRIAC (corte de fase) DALI bajo pedido

* Bombilla no incluida



ACABADOS



DIMENSIONES Y EMBALAJE

Cuerpo	Ø25x150cm
Longitud del cable	170cm
Peso neto	3,5kg
Medida bulto 1	20x20x170
Medida bulto 2	30x30x30
Volumen bulto 1	0,064m³
Volumen bulto 2	0,027m³
Peso total bultos	4,5kg

MANTENIMIENTO

Limpiar con un paño suave. No utilizar productos amoniacales, disolventes o abrasivos.

IMAGE



* Image not representative of the actual model (REF. 6023)

DESCRIPTION

Pendant, wall, table, ceiling and floor family lamps. Shade made of oak, lacquered and decorated in gray or dark gray. All shades with their opal diffuser made of polyester. The metal parts can be decorated in brass or dark bronze.

GENERAL SPECIFICATIONS

Installation	Floor
Ambient	Indoor
IP	20

MATERIALS

Shade	Wood
Body	Metal
Diffuser	Acrylic

FINISHES

Oak	Natural, Dark
Metal	Bronze, Brass, Antique Brass
Acrylic	Satinice

GENERAL DIMENSIONS

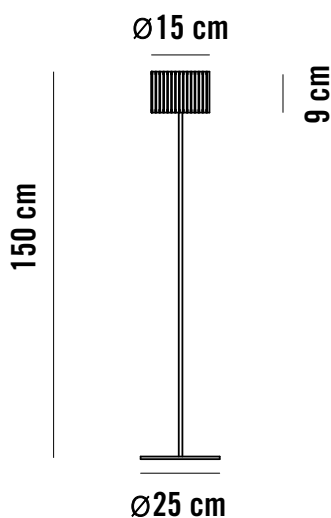

ELECTRICAL CHARACTERISTICS

Safety class	Class I
Light source	LED
LED type	G9
Rated input wattage	1 x 3W
Colour Temperature	2700K
AC Voltage	220-240v
Frequency	50-60Hz
Dimmer <i>(Subject to dimmable light bulb*)</i>	TRIAC <i>(phase cut)</i> DALI on request

* Light bulb not included



FINISHES

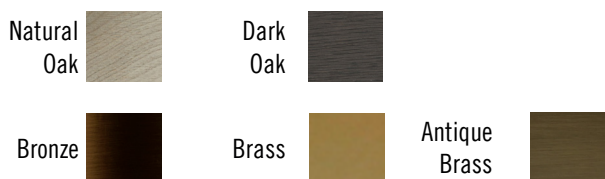

DIMENSIONS AND PACKAGING

Body	Ø25x150cm
Cable length	170cm
Net weight	3.5kg
Box 1 dimension	20x20x170
Box 2 dimension	30x30x30
Box 1 volume	0.064m³
Box 2 volume	0.027m³
Total Boxes weight	4.5kg

MAINTENANCE

Clean with a smooth cloth. Do not use ammonia, solvents or abrasive cleaning products.

IMAGEN



DESCRIPCIÓN

Lámparas de suspensión, pared, sobremesas, plafón y pies de salón con pantalla de roble erosionado en laca decorada en gris o gris oscuro. Todas las pantallas llevan su difusor de poliéster opal. Las partes metálicas pueden ser decoradas en bronce oscuro o latón.

ESPECIFICACIONES GENERALES

Montaje	Mesa
Ambiente	Interior
IP	20

MATERIALES

Pantalla	Madera
Base	Metal
Difusor	Acrílico

ACABADOS

Madera	Roble Natural, Roble Oscuro
Metal	Bronce, Latón, Cuero
Acrílico	Satinice

COTAS GENERALES

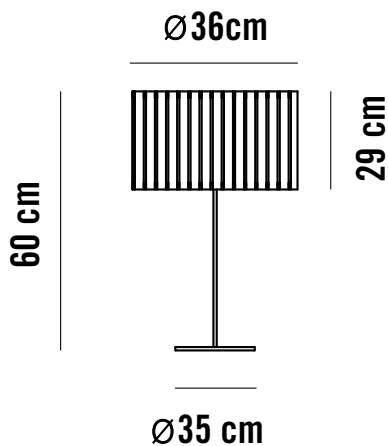

CARACTERÍSTICAS ELÉCTRICAS

Clase de aislamiento	Clase II
Tipo fuente de luz	LED
Tipo LED	E27
Potencia total	1 x 7W
Temperatura de color	2700K
Voltaje AC	220-240v
Frecuencia	50-60Hz
Regulación (<i>Sujeto a bombilla* regulable</i>)	TRIAC (<i> corte de fase</i>) DALI bajo pedido

* Bombilla no incluida



ACABADOS



DIMENSIONES Y EMBALAJE

Cuerpo	Ø36x60cm
Longitud cable	170cm
Peso neto	4kg
Medida bulto 1	40x40x40cm
Volumen bulto	0,045m³
Peso bulto	3kg

MANTENIMIENTO

Limpiar con un paño suave. No utilizar productos amoniacales, disolventes o abrasivos.

IMAGE



DESCRIPTION

Pendant, wall, table, ceiling and floor family lamps. Shade made of oak, lacquered and decorated in gray or dark gray. All shades with their opal diffuser made of polyester. The metal parts can be decorated in brass or dark bronze.

GENERAL SPECIFICATIONS

Installation	Table
Ambient	Indoor
IP	20

MATERIALS

Shade	Wood
Body	Metal
Diffuser	Acrylic

FINISHES

Oak	Natural, Dark
Metal	Bronze, Brass, Antique Brass
Acrylic	Satinice

GENERAL DIMENSIONS

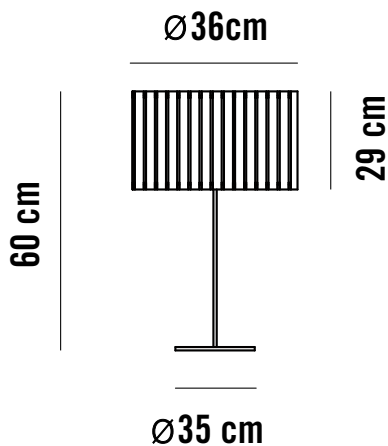

ELECTRICAL CHARACTERISTICS

Safety class	Class I
Light source	LED
LED type	E27
Rated input wattage	1 x 7W
Colour Temperature	2700K
AC Voltage	220-240v
Frequency	50-60Hz
Dimmer <i>(Subject to dimmable light bulb*)</i>	TRIAC <i>(phase cut)</i> DALI on request

* Light bulb not included



FINISHES

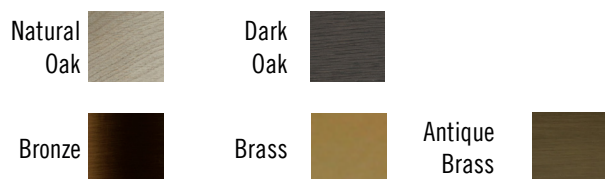

DIMENSIONS AND PACKAGING

Body	Ø36x60cm
Cable length	170cm
Net weight	4kg
Box dimension	40x40x40cm
Box volume	0.064m ³
Box weight	5.25kg

MAINTENANCE

Clean with a smooth cloth. Do not use ammonia, solvents or abrasive cleaning products.

IMAGEN



* La imagen corresponde al modelo 6026

DESCRIPCIÓN

Lámparas de suspensión, pared, sobremesas, plafón y pies de salón con pantalla de roble erosionado en laca decorada en gris o gris oscuro. Todas las pantallas llevan su difusor de poliéster opal. Las partes metálicas pueden ser decoradas en bronce oscuro o latón.

ESPECIFICACIONES GENERALES

Montaje	Mesa
Ambiente	Interior
IP	20

MATERIALES

Pantalla	Madera
Base	Metal
Difusor	Acrílico

ACABADOS

Madera	Roble Natural, Roble Oscuro
Metal	Bronce, Latón, Cuero
Acrílico	Satinice

COTAS GENERALES

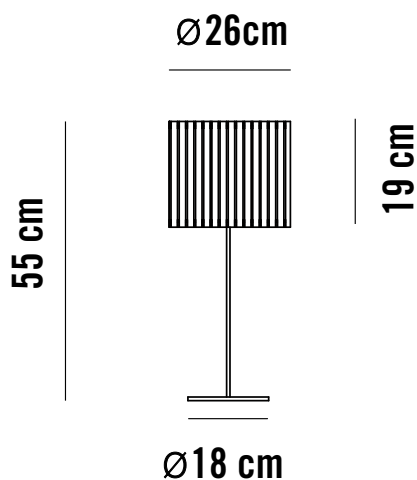

CARACTERÍSTICAS ELÉCTRICAS

Clase de aislamiento	Clase I
Tipo fuente de luz	LED
Tipo LED	E27
Potencia total	1 x 4W
Temperatura de color	2700K
Voltaje AC	220-240v
Frecuencia	50-60Hz
Regulación (Sujeto a bombilla* regulable)	TRIAC (corte de fase) DALI bajo pedido

* Bombilla no incluida



ACABADOS



DIMENSIONES Y EMBALAJE

Cuerpo	Ø26x55cm
Longitud cable	170cm
Peso neto	2,10kg
Medida bulto 1	30x30x50cm
Volumen bulto	0,045m ³
Peso bulto	3kg

MANTENIMIENTO

Limpiar con un paño suave. No utilizar productos amoniacales, disolventes o abrasivos.

IMAGE



* Image not representative of the actual model (REF. 6026)

DESCRIPTION

Pendant, wall, table, ceiling and floor family lamps. Shade made of oak, lacquered and decorated in gray or dark gray. All shades with their opal diffuser made of polyester. The metal parts can be decorated in brass or dark bronze.

GENERAL SPECIFICATIONS

Installation	Table
Ambient	Indoor
IP	20

MATERIALS

Shade	Wood
Body	Metal
Diffuser	Acrylic

FINISHES

Oak	Natural, Dark
Metal	Bronze, Brass, Antique Brass
Acrylic	Satinice

GENERAL DIMENSIONS

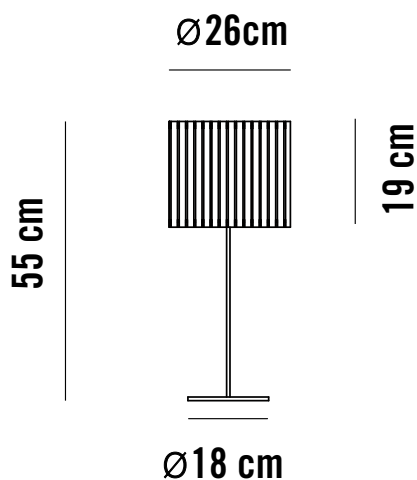

ELECTRICAL CHARACTERISTICS

Safety class	Class I
Light source	LED
LED type	E27
Rated input wattage	1 x 4W
Colour Temperature	2700K
AC Voltage	220-240v
Frequency	50-60Hz
Dimmer (Subject to dimmable light bulb*)	TRIAC (phase cut) DALI on request

* Light bulb not included



FINISHES

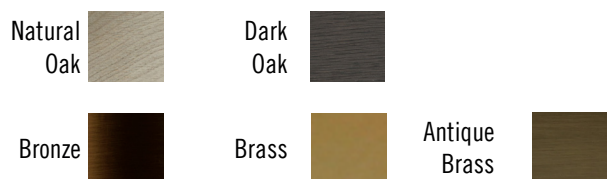

DIMENSIONS AND PACKAGING

Body	Ø26x55cm
Cable length	170cm
Net weight	2.10kg
Box dimension	30x30x50cm
Box volume	0.045m³
Box weight	3kg

MAINTENANCE

Clean with a smooth cloth. Do not use ammonia, solvents or abrasive cleaning products.

IMAGEN



* La imagen corresponde al modelo 6026

COTAS GENERALES

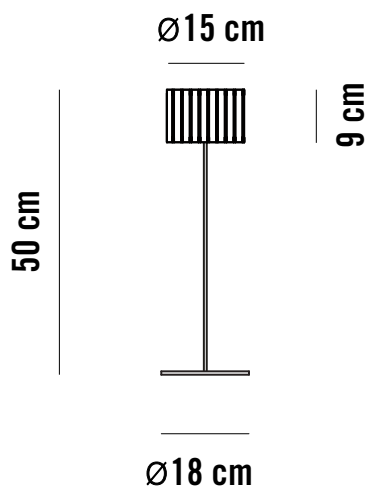

ACABADOS



MANTENIMIENTO

Limpiar con un paño suave. No utilizar productos amoniacales, disolventes o abrasivos.

DESCRIPCIÓN

Lámparas de suspensión, pared, sobremesas, plafón y pies de salón con pantalla de roble erosionado en laca decorada en gris o gris oscuro. Todas las pantallas llevan su difusor de poliéster opal. Las partes metálicas pueden ser decoradas en bronce oscuro o latón.

ESPECIFICACIONES GENERALES

Montaje	Mesa
Ambiente	Interior
IP	20

MATERIALES

Pantalla	Madera
Base	Metal
Difusor	Acrílico

ACABADOS

Madera	Roble Natural, Roble Oscuro
Metal	Bronce, Latón, Cuero
Acrílico	Satinice

CARACTERÍSTICAS ELÉCTRICAS

Clase de aislamiento	Clase I
Tipo fuente de luz	LED
Tipo LED	G9
Potencia total	1 x 3W
Temperatura de color	2700K
Voltaje AC	220-240v
Frecuencia	50-60Hz
Regulación (Sujeto a bombilla* regulable)	TRIAC (corte de fase) DALI bajo pedido

* Bombilla no incluida



DIMENSIONES Y EMBALAJE

Cuerpo	Ø18x50cm
Longitud de cable	170cm
Peso neto	1,2kg
Medida bulto 1	30x30x66cm
Volumen bulto	0,0594m ³
Peso bulto	2,8kg

IMAGE



* Image not representative of the actual model (REF. 6026)

DESCRIPTION

Pendant, wall, table, ceiling and floor family lamps. Shade made of oak, lacquered and decorated in gray or dark gray. All shades with their opal diffuser made of polyester. The metal parts can be decorated in brass or dark bronze.

GENERAL SPECIFICATIONS

Installation	Table
Ambient	Indoor
IP	20

MATERIALS

Shade	Wood
Body	Metal
Diffuser	Acrylic

FINISHES

Oak	Natural, Dark
Metal	Bronze, Brass, Antique Brass
Acrylic	Satinice

GENERAL DIMENSIONS

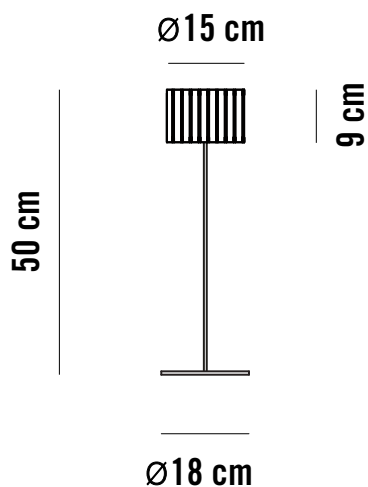

ELECTRICAL CHARACTERISTICS

Safety class	Class I
Light source	LED
LED type	G9
Rated input wattage	1 x 3W
Colour Temperature	2700K
AC Voltage	220-240v
Frequency	50-60Hz
Dimmer (Subject to dimmable light bulb*)	TRIAC (phase cut) DALI on request

* Light bulb not included



FINISHES

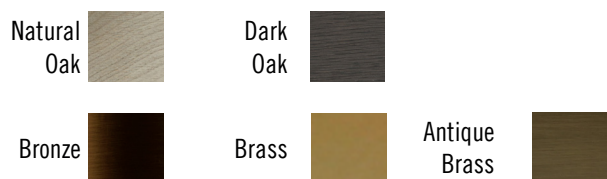

DIMENSIONS AND PACKAGING

Body	Ø18x50cm
Cable length	170cm
Net weight	1.2kg
Box dimension	30x30x66cm
Box volume	0.0594m ³
Box weight	2.8kg

MAINTENANCE

Clean with a smooth cloth. Do not use ammonia, solvents or abrasive cleaning products.

IMAGEN



DESCRIPCIÓN

Lámparas de suspensión, pared, sobremesas, plafón y pies de salón con pantalla de roble erosionado en laca decorada en gris o gris oscuro. Todas las pantallas llevan su difusor de poliéster opal. Las partes metálicas pueden ser decoradas en bronce oscuro o latón.

ESPECIFICACIONES GENERALES

Montaje	Pared
Ambiente	Interior
IP	20

MATERIALES

Cuerpo	Madera
Base	Metal
Difusor	Acrílico

ACABADOS

Madera	Roble Natural, Roble Oscuro
Metal	Bronce, Latón, Cuero
Acrílico	Satinice

COTAS GENERALES

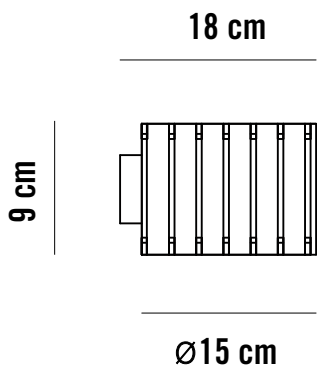

CARACTERÍSTICAS ELÉCTRICAS

Clase de aislamiento	Clase I
Tipo fuente de luz	LED
Tipo LED	G9
Potencia total	1 x 3W
Temperatura de color	2700K
Voltaje AC	220-240v
Frecuencia	50-60Hz
Regulación <i>(Sujeto a bombilla* regulable)</i>	TRIAC <i>(corte de fase)</i> DALI bajo pedido

* Bombilla no incluida



ACABADOS



DIMENSIONES Y EMBALAJE

Cuerpo	18x9cm
Peso neto	0,40kg
Medida bulto 1	20x20x30cm
Volumen bulto	0,012m ³
Peso bulto	1,2kg

MANTENIMIENTO

Limpiar con un paño suave. No utilizar productos amoniacales, disolventes o abrasivos.

IMAGE



DESCRIPTION

Pendant, wall, table, ceiling and floor family lamps. Shade made of oak, lacquered and decorated in gray or dark gray. All shades with their opal diffuser made of polyester. The metal parts can be decorated in brass or dark bronze.

GENERAL SPECIFICATIONS

Installation Wall
 Ambient Indoor
 IP 20

MATERIALS

Shade Wood
 Body Metal
 Diffuser Acrylic

FINISHES

Oak Natural, Dark
 Metal Bronze, Brass, Antique Brass
 Acrylic Satinice

GENERAL DIMENSIONS

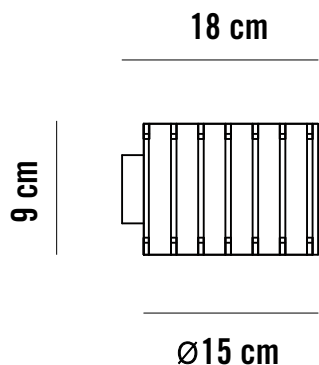

ELECTRICAL CHARACTERISTICS

Safety class Class I
 Light source LED
 LED type G9
 Rated input wattage 1 x 3W
 Colour Temperature 2700K
 AC Voltage 220-240v
 Frequency 50-60Hz
 Dimmer (Subject to dimmable light bulb*) TRIAC (phase cut)
 DALI on request

* Light bulb not included



FINISHES

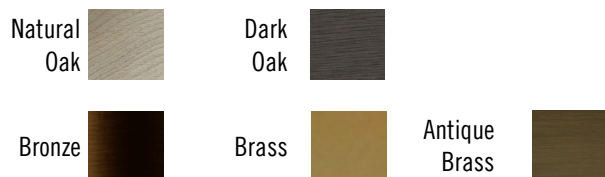

DIMENSIONS AND PACKAGING

Body 18x9cm
 Net weight 0.40kg
 Box dimension 20x20x30cm
 Box volume 0.012m³
 Box weight 1.2kg

MAINTENANCE

Clean with a smooth cloth. Do not use ammonia, solvents or abrasive cleaning products.

IMAGEN

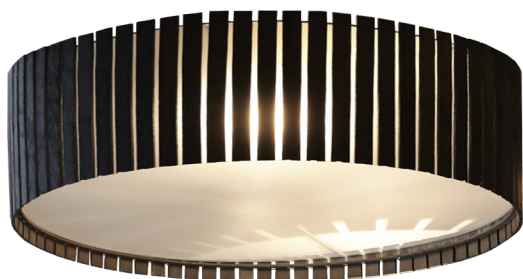

DESCRIPCIÓN

Lámparas de suspensión, pared, sobremesas, plafón y pies de salón con pantalla de roble erosionado en laca decorada en gris o gris oscuro. Todas las pantallas llevan su difusor de poliéster opal. Las partes metálicas pueden ser decoradas en bronce oscuro o latón.

ESPECIFICACIONES GENERALES

Montaje	Techo
Ambiente	Interior
IP	20

MATERIALES

Cuerpo	Madera
Difusor	Acrílico

ACABADOS

Roble	Natural, Oscuro
PMMA Acrílico	Satinice

COTAS GENERALES

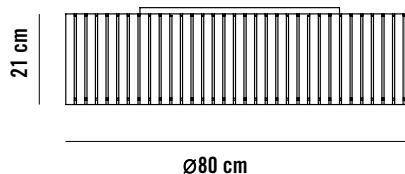

CARACTERÍSTICAS ELÉCTRICAS

Clase de aislamiento	Clase I
Tipo fuente de luz	LED
Tipo LED	E27
Potencia total	4 x 12W
Temperatura de color	2700K
Voltaje AC	220-240v
Frecuencia	50-60Hz
Regulación (<i>Sujeto a bombilla* regulable</i>)	TRIAC (<i> corte de fase</i>) DALI bajo pedido

* Bombilla no incluida



ACABADOS



DIMENSIONES Y EMBALAJE

Cuerpo	Ø80x21cm
Peso neto	9,35kg

Medida bulto 1	90x90x30cm
Volumen bulto	0,243m ³
Peso bulto	16kg

MANTENIMIENTO

Limpiar con un paño suave. No utilizar productos amoniacales, disolventes o abrasivos.

IMAGE

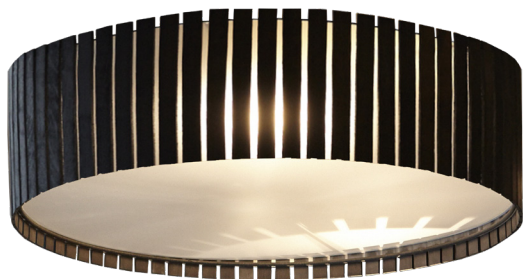

DESCRIPTION

Pendant, wall, table, ceiling and floor family lamps. Shade made of oak, lacquered and decorated in gray or dark gray. All shades with their opal diffuser made of polyester. The metal parts can be decorated in brass or dark bronze.

GENERAL SPECIFICATIONS

Installation Ceiling
 Ambient Indoor
 IP 20

MATERIALS

Body Wood
 Diffuser Acrylic

FINISHES

Oak Natural, Dark
 Acrylic Satinice

GENERAL DIMENSIONS

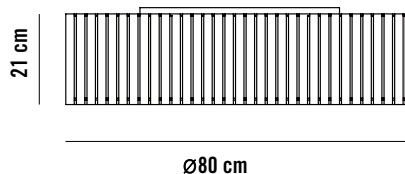

ELECTRICAL CHARACTERISTICS

Safety class Class I
 Light source LED
 LED type E27
 Rated input wattage 4 x 12W
 Colour Temperature 2700K
 AC Voltage 220-240v
 Frequency 50-60Hz
 Dimmer (Subject to dimmable light bulb*) TRIAC (phase cut)
 DALI on request

* Light bulb not included



FINISHES



DIMENSIONS AND PACKAGING

Body Ø80x21cm
 Net weight 9.35kg

Box dimension 90x90x30cm
 Box volume 0.243m³
 Box weight 16kg

MAINTENANCE

Clean with a smooth cloth. Do not use ammonia, solvents or abrasive cleaning products.